

Approach to the Social mechanism to reduce the CO2 emission from existing buildings

Hiroshi.SAKO*, Bumpei.MAGORI*, Tomonari.YASHIRO*
Hayato.FUJII**, Yoshikazu.MIZUTANI**,
the University of Tokyo*, Woodnote corporation**

ABSTRACT: This paper points out about the possibility to reduce CO2 emission from the existing building operation which is left by any business parties. Many existing building are not operated efficiently in terms of energy consumption. This paper introduces a field study for the analysis of the energy consumption in the existing building. This study verifies that making the detail analysis of building facility operation can reduce the energy consumption in the existing building. In addition, this paper proposes one approach to the social mechanism in order to reduce the CO2 emission from the existing building.

KEYWORDS: Energy management system, energy conservation, CO2 emission

1. INTRODUCTION

This paper points out about the possibility to reduce CO2 emission from the existing building operation which is left by any business parties. In many of the existing buildings, the building facility, such as heating, ventilation and air-conditioning are operated according to the assumption by MEP designers when the building is completed. But such assumption is based on the full-load operation of the building. And also such assumption is based on the condition that it makes many of the occupancy comfortable without any complain. But in reality, the building operation turns out to be partial-load. Therefore in many building, the operation of building facility is not efficient. On the other hand, building owner does not know that by optimizing the building facility operation, it is possible to reduce CO2 emission, and not by forcing the occupancy endure. In order to reduce the CO2 emission from existing buildings steadily, it is urgent to create new business market that analyze and optimize the energy usage of the existing building.

2. LIFE OF BUILDING AND TERM WHICH IS LEFT BY ANY BUISINESS PARTIES

In the design process of new buildings, MEP engineers usually proceed their design considering how to make energy conservation building. Construction engineers build up the building and set up MEP equipment based on the design specification. It is biggest concern for MEP designers and construction engineers that they will not receive any complain about indoor comfortableness from clients and occupancy after completion. In fact, they do not have any chance to know real operation of building facility if they do not have any complains from clients after completion. On the other hand, the optimization of the operation of building facilities (commissioning) can be done after completion. But Design office and contractor's scope is only in the design and build or in the renewal work. Therefore operating method of MEP equipment is left as it is without any consideration, analysis, and optimization from building completion to building renewal, around 20 years.

These 20 years is the term which is left by any business parties.(Figure 1.) Sometimes in major buildings partially commissioning is done after completion. And also ESCO (Energy Service Company) handles the energy conservation business in the field of minimizing. But these businesses apply for the only major building and the approach is often limited to the part of the MEP equipment. Therefore many of the existing building consume inefficiently huge energy.

3. FIELD STUDY ABOUT ANALYSIS OF ENERGY CUMSUMPTION

This paper reports the field study about the efficiency of MEP operation in Isogo ward office, Yokohama-city. It was verified the possibility to reduce energy consumption by analysis and optimization for MEP operation.

3.1 Building summary

Field study building was completed in 1999. This building has B3, F8, P1 stories and total area is 24,335 m². Building type is ward office with public hall (600 seats). Operation hours of this building is from 8:45~17:00 in weekday.

This building is equipped many energy conservation system, such as high efficient absorption chiller, variable water volume control, variable air volume control, cooling system by using the outside air, high frequency lighting fixture, the ice thermal storage system. This building can be called ‘the energy conservation building’ .

Detail specification of heating and cooling source is shown in Table 1 and Figure 2. RB1-1, RB1-2 supply cool and hot water for ward office. And RB2-1supply cool and hot water for hall. BCU1, 2 with ice tank supply cool water and hot water for whole building. Air-conditioning type in this building is AHU and 28 units are installed. One AHU is installed in each approx. 600 m².

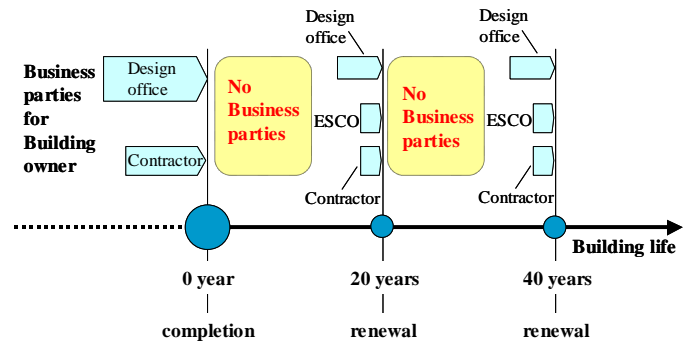

Figure 1. Life of building and stakeholder



Photo 1. Building façade

Table 1. Specification of Heating and Cooling source

No	Item	Capacity	Number
RB1-1	Absorption chiller	3,038MJ	1
RB1-2	Absorption chiller	3,038MJ	1
RB2-1	Absorption chiller	1,645MJ	1
BCU	Heat pump chiller	633MJ	2
No1, 2	Ice storage tank	4,950MJ/d	

Total 8,987MJ + Ice tank

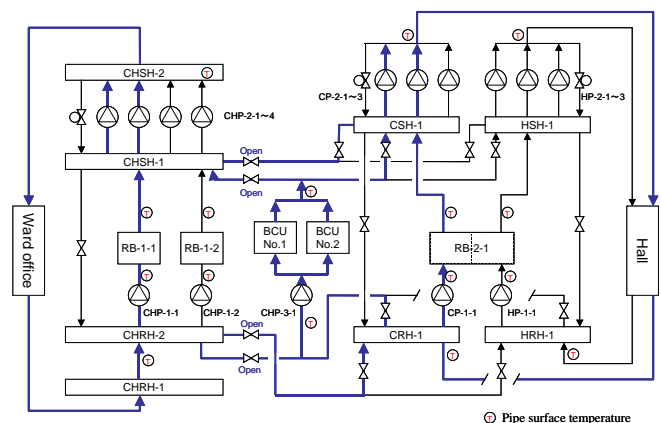

Figure 2. Heating and cooling source diagram

3.2 Analysis procedure

Firstly it was confirmed annually, monthly, daily energy consumption. Secondly we asked to MEP manager of this building, what is real MEP operation. In this confirmation, we utilized the energy conservation diagnose table which is composed of 52 items. Finally following 4 items were extracted for analyzing items. These items should contain the possibility to reduce the energy consumption.

- (a) Monitoring and analysis for power demand
- (b) Verification for efficiency of heating and cooling source
- (c) Installing CO2 controller and verification this effect
- (d) Release this conservation activity and effect for Yokohama city office

For this analysis, the existing measurement points are not enough to verify the efficiency of heating and cooling source. Watt-hour meter and pipe surface temperature meter were added as Table 2 and Figure 2. In addition, Density meter of CO2 and AHU dumper controller were installed for CO2 control. Additional 63 meters and controllers were installed totally. This measurement started from 2009-6-28 and ended to 2009-9-17.

3.3 Analysis method and result

3.3.1 Monitoring and analysis for power demand

Peak power demand was 908.8kW in this measurement term. Figure 3 shows the order of every hour power demand. Total number of demand data is 2016h in the horizontal axis. Peak power demands are composed in only few hours, which are highlighted with the circle line in Figure 3.

20 every hour power demands from maximum order are extracted from Figure 3. It is shown in Figure 4. It is recognized the possibility to cut the peak power demand form 908.8kW to 830kW, if higher ranking 7 hours power demand could be controlled. It should be prepared to stop the

equipment operation which will not affect building operation instantly, such as ventilation, when peak demand would get over 830kW. If this preparation and detail monitoring for power demand would be done, 8.5% power demand can be cut. Cut of peak power demand not only make saving electricity fee and also make efficient operation in power plant station.

Table 2. Measurement and Monitoring points

Item (meter, controller)	Num of New installation
Watt hour meter	12
Pipe Surface temperature	16
Air-temperature	7(office)+1(outside)
Air-humidity	7(office)+1(outside)
Density of CO2	7(office)
Cooling source status	5 (each source)
AHU dumper controller	7(office)
Total	63

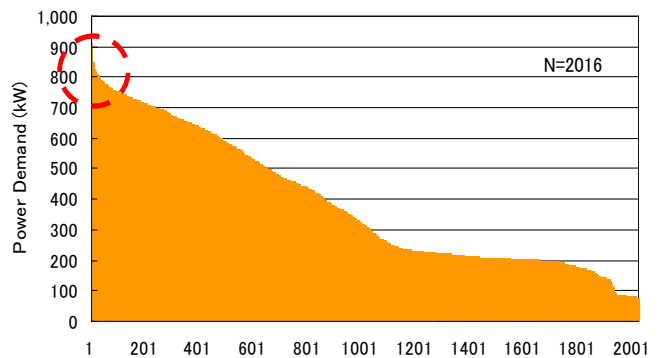

Figure 3. Order of Power demand (all data)

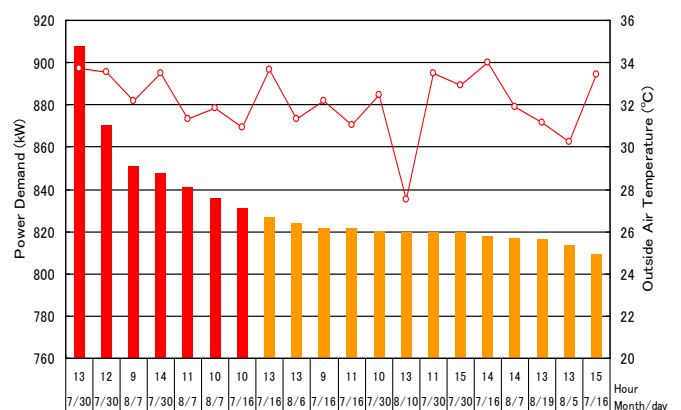

Figure 4. Order of Power demand (top 20 data)

3.3.2 Verification for efficiency of heating and cooling source

Figure 5 shows daily operation records of heating and cooling source from 26th-July to 8th-Aug. Cooling source started operation at around 7AM every day. Discharge from Ice storage operated on base operation and absorption chiller supplement the rest of the cooling load. Number of operating chiller is fitted for cooling load. RB1-1and RB1-2 operates mutually day by day. RB2-1 operates based on use of hall. Total capacity of cooling source is 8,987MJ, however real cooling load was almost half of them, 4500MJ was peak cooling load.

Verification result of system-COP for each chiller is shown in Figure 6 and 8. System-COP is defined that produced cooling capacity is divided by total input energy, including gas for chiller, power for cooling tower and primary pump and cooling tower pump. The optimum system-COP is 0.78. However real system-COP is maxim=0.8, average=0.44 for R-1-1 and maximum=0.65, average=0.30 for R-1-2. It was verified that system-COP of R-1-2 was quite low from optimum value.

Figure 7 and 9 shows the frequency of output energy from each chiller. Output energy by R-1-1 is less than 40% in the 50% of operating hour.

Output energy by R-1-2 is less than 40% in the 67% of operating hour. Absorption chiller has special quality that partial load operation, less than 25%, is quite low efficiency. It was verified that these two chiller capacities does not suit for real thermal load and operated in low efficiency.

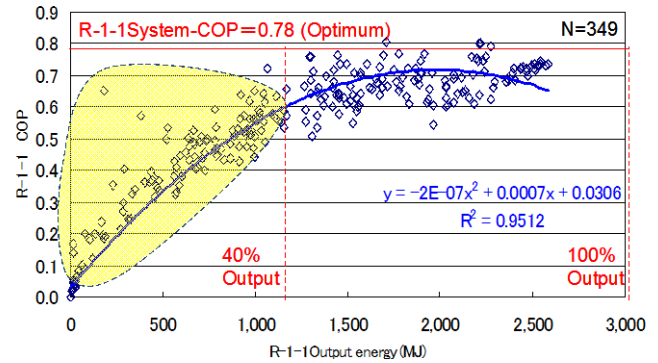

Figure 6. Output and system-COP (R1-1)

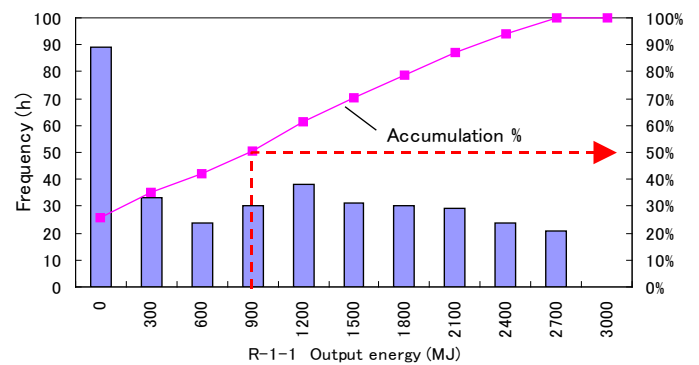

Figure 7. Frequency of cooling output (R1-1)

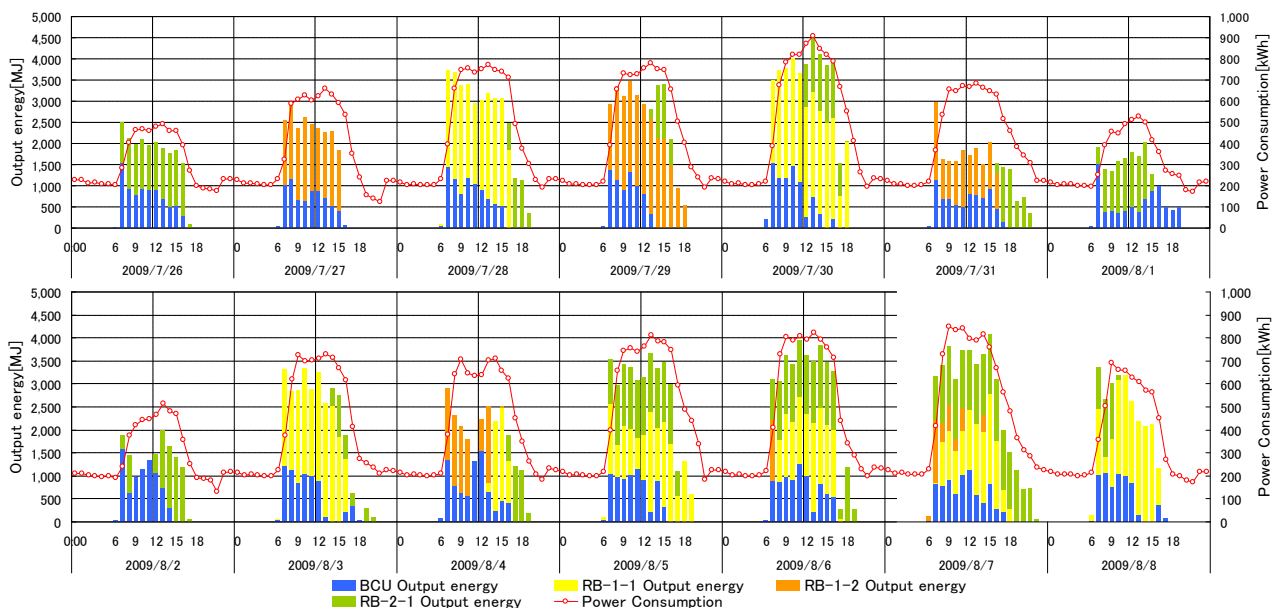

Figure 5. Operation records of cooling source

Figure 10 shows system-COP about R-2-1. R-2-1 is operated during hall use. Therefore there are not so many partial load operation such as R-1-1, R-1-2. Mostly R-2-1 is operated with full load. System-COP about R-2-1 kept high value, average=0.64.

The ice thermal storage system operates with almost full load during the night time certainly. Figure 11 verify that system-COP about ice thermal storage system keep high value, the average of system-COP is 0.72 that is almost same as optimum value '0.73'. (System-COP about ice thermal storage system was calculated that daily total cooling output is divided by daily total power supply for heat pump.) But daily cooling capacity utilizing the ice thermal tank is from 62% to 84%. It should be possible to use 100% capacity of the ice thermal storage tank.

Following knowledge is summarized from verification for the efficiency of heating and cooling source

- Number of operating chiller is properly.
- R-1-1 and R1-2 were operated mostly in low efficient, because of partial load.
- Especially R1-2 was operated in low system-COP.
- R-2-1 was operated in high enough efficient.
- The ice storage system is operated in high COP.
- The ice storage system can not use full capacity.

Following countermeasure should be considered.

- Small capacity chiller such as R2-1 should use on base operation, instead of R-1-1 and R1-2
- Investigation by supplier should be done for R1-2. (Coil part might have some fault)
- Investigation for the ice storage system should be done that measurement in the ice tank is properly or not.

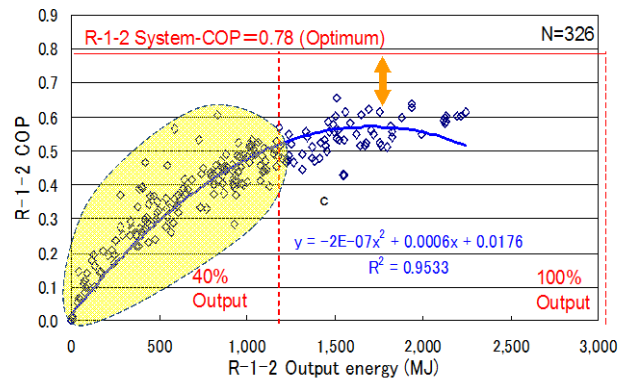

Figure 8. Output and system-COP (R1-2)

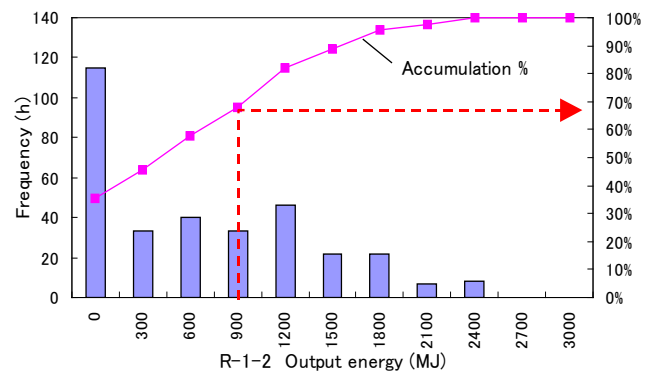

Figure 9. Frequency of cooling output (R1-2)

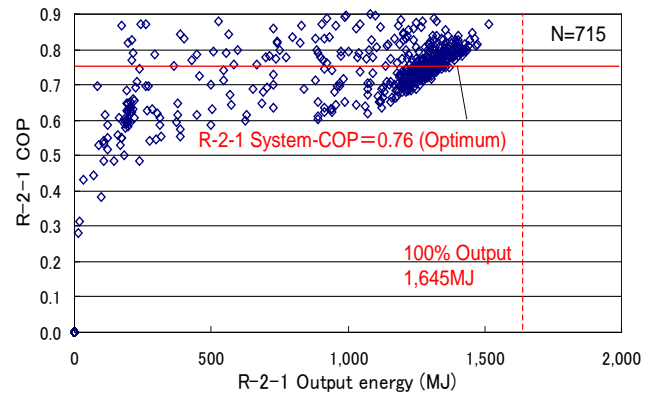

Figure 10. Output and system-COP (R2-1)

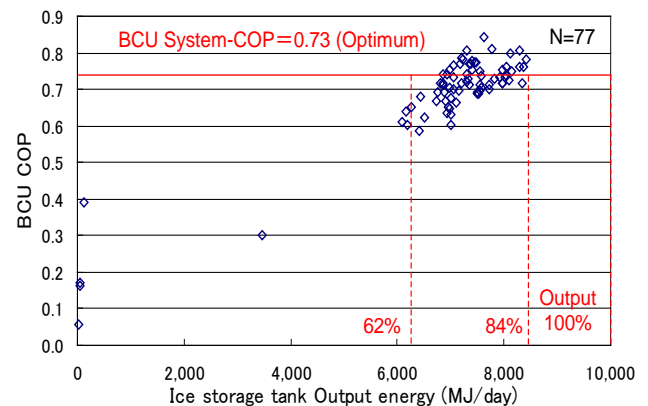

Figure 11. Output and system-COP (Ice storage system)

3.3.3 Installing CO2 controller and verification

the effect

Ventilation method of this building is that AHU unit supply fresh air into the office constantly. CO2 control is one of effective solution for the building which supplies fresh air constantly. CO2 controller measures density of CO2 in the office area and control fresh air volume within 1000ppm of CO2. In this building, 7 number of CO2 controller is installed for huge office area from B1F to F6, totally 4,075 m².

In order to verify CO2 control effects, the density of CO2 and the energy consumption are compared between 27th – 29th July and 3rd -5th Aug. Figure 12 shows fresh air dumper status in B1F,2F,3F. During July, fresh air dumper was totally opened. After installing CO2 controller, fresh air dumper was almost closed during the morning time, some dumper was partially opened from the afternoon time. The density of CO2 was kept within 1000ppm in July and Aug. (Figure13)

Figure14 shows the difference of cooling load between the average of 3days in July and the average of 3days in Aug. The outside air temperature in these days was approximate. Therefore this difference of cooling load should be the effect of CO2 control. From this study it was verified that excessive OA was introduced against the real office use.

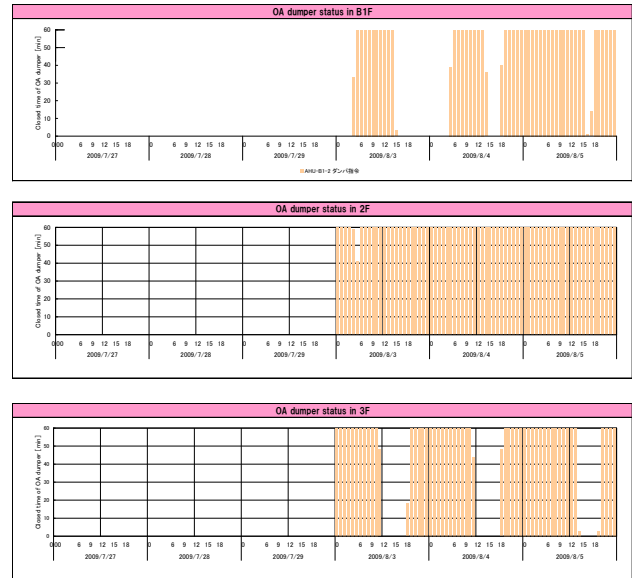

Figure 12. Status of OA dumper

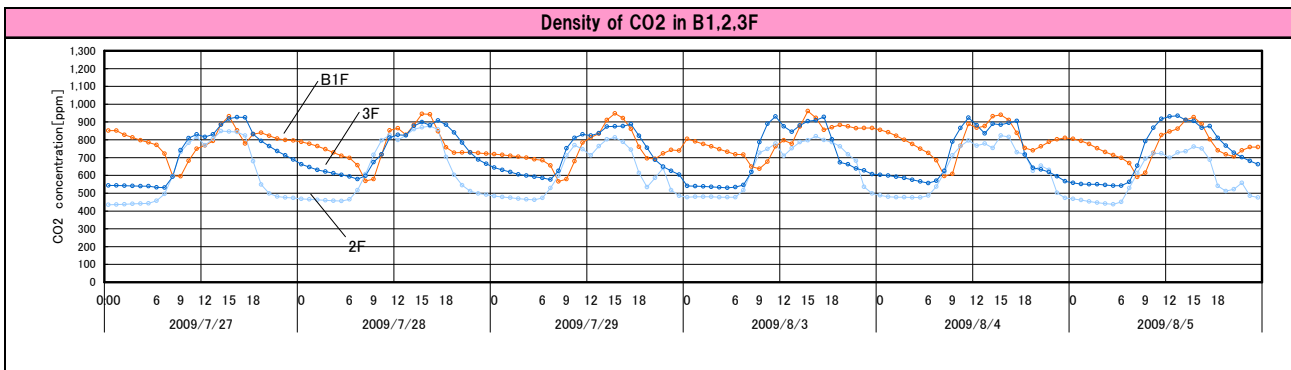

Figure 13. Density of CO2 in B1F, 2F, 3F

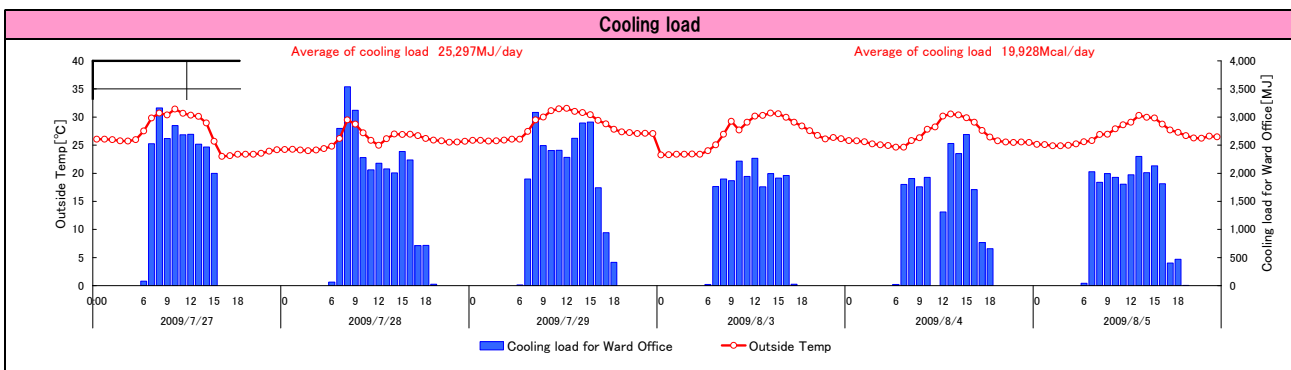

Figure 14. The difference of cooling load

3.3.4 Release this conservation activity and effect for all Yokohama city office

This field study was discussed with Yokohama city office. In order to spread this activity into many co-worker in Yokohama city office, and make many co-worker are aware of energy consumption, this activity was published in web-site. Everyone can understand real-time energy consumption and indoor air-temperature and so on.



Figure 15. Sample of web-site

4. PROPOSED SOCIAL MECHANISM TO REDUCE CO2 EMISSION

Based on above study, this paper proposes one social mechanism in order to apply this kind of field study into general public.

Firstly creating a certification of the energy-efficiency-performance is critical. By certification people can find out how efficiently existing building use the energy. The certification should influence the real estate value when real estate appraiser examines the building.

Secondly, the certification of repair effectiveness performance should be also created. This certification is issued based on energy efficiency when a building is partially reconstructed from energy conservation point of view. Building owners with certification of repair effectiveness performance can be subsidized by government or can be obtained low-interest funds from the bank.

Accordingly public-service corporation must be founded in order to issue these two certifications.

By this social mechanism many building owners have incentive to achieve high efficient operations in their buildings as their assets obtain extra value in balance sheet. As result, many of existing buildings are geared toward low CO2 emission.

5. CONCLUSION

1. It was pointed out about the possibility to reduce CO2 emission from the existing building operation

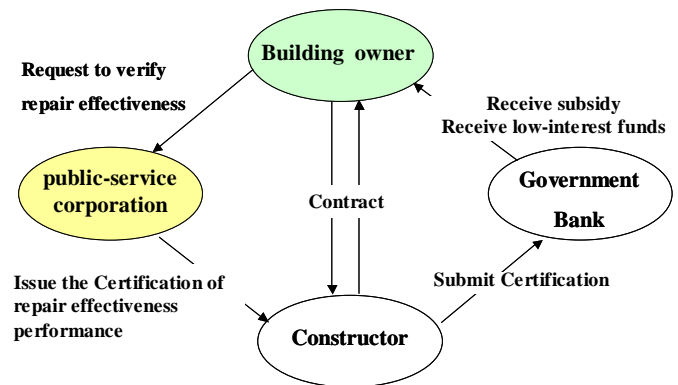

Figure 16. Relation of repair effectiveness performance

which is left by any business parties.

2. Main reason why this possibility exists is that there are no business parties in order to analyze and optimize the energy use of the building from building completion to renewal
3. Through the field study, it was verified that analyzing and optimizing the energy use of the building could reduce the energy consumption.
4. In order to spread this kind of field study into general public, it is proposed creating two certifications which are relation to real estate value.

Special thanks

This field study was completed thanks to united efforts of City of YOKOHAMA. Especially we would like to express our great thanks to Manager Mr.Hamasaki, and Manager Mr.Takahashi, Manager Mr.Okutsu, and Manager Mr.Yamaoka.